

# Bespoke drawers

## Order form solid wood

Request <input type="checkbox"/>	Order <input type="checkbox"/>	Desired delivery	Ref. / Commission	Häfele customer no.	Sales office Jönköping, SWEDEN
-------------------------------------	-----------------------------------	------------------	-------------------	---------------------	-----------------------------------

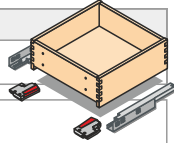

Company: \_\_\_\_\_ Person in charge: \_\_\_\_\_

Address: \_\_\_\_\_ Tel.-No.: \_\_\_\_\_

\_\_\_\_\_ E-mail: \_\_\_\_\_

	e.g.	Pos 1	Pos 2	Pos 3	Pos 4	Pos 5	Pos 6
<b>Quantity (pieces)</b>	3						
<b>Type of drawer</b> CLASSIC drawers: SE-50 / 51 / 52 / 53 inner dra.: SE-54 / 61 / 65 / 66; low-front: SE-56 / 63 / 64 pull-out (with rails): SE-72 / 73; drawer-box: SE-55 / 90 wardrobe solution „plus“: SE-20 / 21 / 22 / 29 PREMIUM: SE-40 / 41 / 42 / 43 / 44 / 45 / 46 ECO: SE-12 / SE-13 / SE-16	The drawer type defines the shape, corner connection joined / dowelled) and assembly state (assembled / disassembled). You will find an overview with visualisation and technical details in the product overview on page 4.	53					
<b>Inside cabinet width (mm)</b> <u>alternatively drawer width (mm)</u>	Please specify the inside cabinet width or <u>alternatively</u> the desired width of the drawer!	862					
<b>Inside cabinet depth (mm)</b> <u>alternatively nominal length of runner (mm)</u> <u>alternatively drawer depth (mm)</u>	Please note runner lengths (see below)! Note on drawer depth: drawers for front fixing are 10 mm less deep than runners, inner drawers 3 mm deeper than runners	550					
<b>Height of drawer frame without runner (mm)</b> 55 / 70 / 85 / 100 / 115 / 130 / 160 / 190 / 220 / 250 / 280 / 310 / 340 / 370 / 400		115					
<b>Type of wood</b> steamed beech [SBE] / pale beech [PBE] / maple [MA] / oak [OK] / smoaked oak [SOK] / knotty oak 'prime' [KOP] / oak 'character' [OKC] / americ. walnut [AWN] / black cherry [BC] / birch [BI] / ash [AS] / red elm [ELM] / pine [PIN]		EIC					
<b>Surface</b> nature-lacquered [L] / oiled and waxed [Ö] / nature-effect-lacquered [NL] / whitish-lacquered <sup>1</sup> [WL] / grey-whitish-lacquered <sup>2</sup> [GL] / whitish oiled [WÖ] <sup>3</sup> / raw, sanded [R]	<sup>1</sup> for beech, maple, birch & ash <sup>2</sup> for oak <sup>3</sup> for beech, maple, birch, oak, birch & ash	GL					
<b>Machining front fixing</b> drilled [B] / drilled with centring dowels [C]	Only drawers (SE-40 / 43 / 51 / 52 / 53 / 72 / 73)	B					
<b>Machining handle millings / borings</b> A / B / C / D / F / handle borings [B64 / B96 / ...]	Only inner drawers (SE-16 / 41 / 44 / 46 / 54 / 55 / 61 / 65 / 66) Preview on page 5!						
<b>Bottom loose bottom</b>							
<b>Bottom reinforced bottom (8 mm plywood)</b>	Standard: 5 mm Fupla	X					
<b>Blum Tandem - part extension 30 kg</b> with Blumotion soft close [B] / with TipOn [T] / with TipOn incl. synchronisation [TS]	Runner lengths: 270, 300, 350, 400, 450, 500, 550, 600*, 650* *only without Blumotion soft close available						
<b>Blum Tandem - full extension 30 kg</b> with Blumotion soft close [B] / with TipOn [T] / with TipOn incl. synchronisation [TS]	Runner lengths: 250, 270, 300, 320, 350, 380, 400, 420, 450, 480, 500, 520, 550, 600						
<b>Blum Tandem - full extension 50 kg</b> with Blumotion soft close [B] / with TipOn [T] / with TipOn incl. synchronisation [TS]	Runner lengths: 450, 500, 520, 550, 580, 600, 650, 700, 750						
<b>Blum Movento - full extension 40 kg</b> with Blumotion soft close [B] / with TipOn [T] / with TipOn incl. synchronisation [TS] / with TipOn-Blumotion [TB] / with TipOn-Blumotion incl. synchronisation [TBS]	Runner lengths: 250*, 270, 300, 320, 350, 380, 400, 420, 450, 480, 500, 520, 550, 600 *not as „TipOn-Blumotion“	TBS					
<b>Blum Movento - full extension 60 / 70 kg</b> with Blumotion soft close [B] / with TipOn [T] / with TipOn incl. synchronisation [TS] / with TipOn-Blumotion [TB] / with TipOn-Blumotion incl. synchronisation [TBS]	Runner lengths: 450, 500, 520, 550, 580, 600, 650, 700*, 750* *60 kg maximum load						
<b>Grass Dynapro - full extension 40 / 50 kg</b> with Soft-close [S] / with TipMatic [T] / with TipMatic incl. synchronisation [TS]	Runner len.: 250, 270, 300, 320, 350, 380, 400, 420, 450, 480, 500, 520, 550, 600, 700*, 750* *50 kg maximum load						
<b>Grass Dynapro - full extension 70 kg</b> with Soft-close [S] / with TipMatic [T] / with TipMatic incl. synchronisation [TS]	Runner lengths: 450, 500, 520, 550, 580, 600, 650						
<b>Options</b>	Please make a cross and define on the attached sheet.						
<b>Laser-Logo</b> left [L] / right [R] / both sides [B]	A one-time charge for set-up and sampling applies to the first order.						

# Bespoke drawers

## Order form solid wood

Note: On this page you can add more items to your order or inquiry.

	e.g.	Pos 7	Pos 8	Pos 9	Pos 10	Pos 11	Pos 12	Pos 13	Pos 14	Pos 15
<b>Quantity (pieces)</b>	3									
<b>Type of drawer</b>	53									
<b>Inside cabinet width (mm)</b>	862									
<u>alternatively drawer width (mm)</u>										
<b>Inside cabinet depth (mm)</b>										
<u>alternatively nominal length of runner (mm)</u>	550									
<u>alternatively drawer depth (mm)</u>										
<b>Height of drawer frame without runners (mm)</b>	115									
<b>Type of wppd</b>	EIC									
<b>Surface</b>	L									
<b>Machining front fixing</b>	B									
<b>Machining handle millings / borings</b>										
<b>Bottom loose bottom</b>										
<b>Bottom reinforced bottom (8 mm plywood)</b>	X									
Blum Tandem - part extension 30 kg with Blumotion soft close [B] / with TipOn [T] / with TipOn incl. synchronisation [TS]										
Blum Tandem - full extension 30 kg with Blumotion soft close [B] / with TipOn [T] / with TipOn incl. synchronisation [TS]										
Blum Tandem - full extension 50 kg with Blumotion soft close [B] / with TipOn [T] / with TipOn incl. synchronisation [TS]										
Blum Movento - full extension 40 kg with Blumotion soft close [B] / with TipOn [T] / with TipOn incl. synchronisation [TS] / with TipOn-Blumotion [TB] / with TipOn-Blumotion incl. synchronisation [TBS]	TBS									
Blum Movento - full extension 60 / 70 kg with Blumotion soft close [B] / with TipOn [T] / with TipOn incl. synchronisation [TS] / with TipOn-Blumotion [TB] / with TipOn-Blumotion incl. synchronisation [TBS]										
Grass Dynapro - full extension 40 / 50 kg with Soft-close [S] / with TipMatic [T] / with TipMatic incl. synchronisation [TS]										
Grass Dynapro - full extension 70 kg with Soft-close [S] / with TipMatic [T] / with TipMatic incl. synchronisation [TS]										
<b>Options</b>										
<b>Laser-Logo</b> left [L] / right [R] / both sides [B]										

# SOLID OPTIONS

Note: Please write the item number of the drawer for which the option is intended in the column "for Pos".

**Cutlery insert SmartLine\***

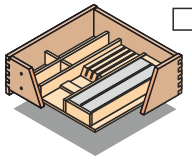

\*available for 490 and 590 mm deep drawers

**Cutlery insert ClassicLine**

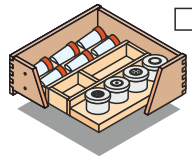

or  
please make a cross

for Pos	Cutlery	Knives	Foil	Spices	Tins
e.g.	X	X	X		

**Dividers and cross dividers**

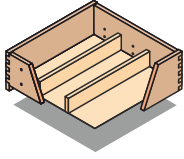
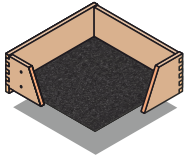

Illustration shows „lengthwise variable“

for Pos	Lengthwise fixed	Length. variable	Crosswise fixed	Crosswise loose	Crossed fixed	Double cross fix
e.g.				4 pcs		

**Insert mats & leather bottom**



for Pos	Needlefelt grey-melted	Anti-slip black	Imit. leather anthracite
e.g.	X		

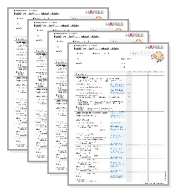

The digital version of this form, information material, type descriptions, drawings and installation aids are available from your Häfele sales office.

Do you need help or advice?

Call us  
**+46 36 180 088**

or send us an e-mail  
**info@hafele.se**

**Siphon cut-out**

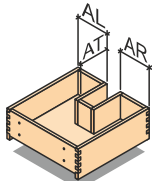

**Note:** Change/correction compared to older versions - note sketch!

for Pos	AL (distance left)	AR (distance right)	AT (depth from back)
e.g.	250	380	220

**Lock milling**

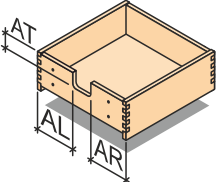

for Pos	AL (distance left)	AR (distance right)	AT (height from top)
z.B.	295	270	120

**Comments**

---



---



---

**How to order**

Please complete the order form directly on your PC or write your order by hand on a printed copy and send it to us

... via e-mail [info@hafele.se](mailto:info@hafele.se)



# Bespoke drawers

## Product overview solid wood drawers

### Classic

<b>Drawers behind fronts</b>				<b>Pull-outs with side railing</b>		
<p><b>SE-50</b> 3-sides, dowelled, unassembled</p>	<p><b>SE-51</b> 4-sides, dowelled, unassembled</p>	<p><b>SE-52</b> 4-sides, dowelled, assembled</p>	<p><b>SE-53</b> 4-sides, jointed, assembled</p>	<p><b>SE-72</b> 4-sides, dowelled, assembled</p>	<p><b>SE-73</b> 4-sides, jointed, assembled</p>	
<b>Inner drawers</b>				<b>Low-front drawers</b>		
<p><b>SE-65</b> Front flush with sides, dowelled</p>	<p><b>SE-66</b> Front protruding below, dowelled</p>	<p><b>SE-54</b> Front flush with sides, jointed</p>	<p><b>SE-61</b> Front protruding below, jointed</p>	<p><b>SE-63</b> Front protruding below, dowelled</p>	<p><b>SE-56</b> Front flush with sides, jointed</p>	<p><b>SE-64</b> Front protruding below, jointed</p>
<b>Drawer-boxes</b>		<b>Wardrobe solution ,plus'</b>				
<p><b>SE-55</b> jointed, assembled</p>	<p><b>SE-90</b> Insert, dowelled, assembled</p>	<p><b>SE-20</b> Front protr. below &amp; to sides, dowelled</p>	<p><b>SE-21</b> Front protr. below &amp; to sides, clear/satin</p>	<p><b>SE-22</b> Front protr. below &amp; to sides, clear/satin</p>	<p><b>SE-29</b> Pull-out for trousers, aluminium traverse</p>	

### Premium

Premium drawers are sanded flat on the top side after assembly. All edges are slightly broken. The bottom made of 8 mm thick veneer board is grooved and glued on 4 sides. The joint spacing is fine and even. The drawers SE-40, SE-41 and SE-42 are supplied with semi-concealed dovetail joints. The front piece of the SE-46 internal drawer is tapped so that it can protrude to the side and conceal the runner.

<p><b>SE-40</b> Drawer, dovetailed</p>	<p><b>SE-41</b> Inner drawer, dovetailed</p>	<p><b>SE-42</b> Low-front drawer, straight / curved side, dovetailed</p>	<p><b>SE-43</b> Drawers, finger jointed</p>	<p><b>SE-44</b> Inner drawer, finger jointed</p>	<p><b>SE-45</b> Low-front drawer, straight side, finger jointed</p>	<p><b>SE-46</b> Inner drawer, protruding on 4 sides, tapped</p>
--	--	--	---	--	---	---

### Eco

Eco drawers are produced similarly to decor drawers and are only available with dowelled corner joints. The drawers are already primed in the profile on both sides and are therefore not sanded flush after assembly. Due to tolerances, there may be a small offset between the front/rear piece and the sides. Eco drawers are only available in the wood types "Steamed beech" and "Oak character".

<p><b>SE-12</b> Drawer, dowelled</p>	<p><b>SE-13</b> Pull-out, dowelled</p>	<p><b>SE-16</b> Inner drawer, dowelled</p>
--	--	--

### Machinings

#### Handle millings / borings

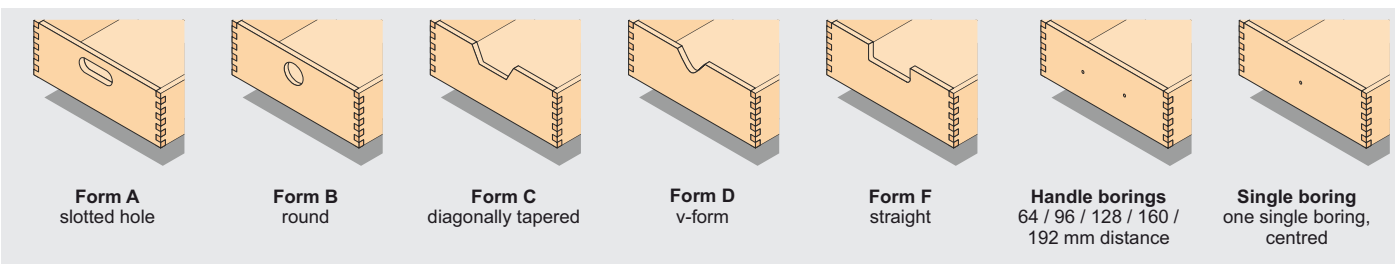

### Types of wood & surfaces

#### Types of wood



#### Surfaces

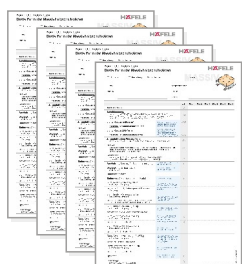

### More information

The digital version of this form, information material, type descriptions, drawings and installation aids are available from your Häfele sales office.

Do you need help  
or advice?

Call us  
**+46 36 180 088**

or send us an e-mail  
**info@hafele.se**