

# Bespoke drawers

## Order form MDF

Inquiry	Order	Desired delivery	Ref. / commission	Häfele customer no.	Sales office
<input type="checkbox"/>	<input type="checkbox"/>				Jönköping, SWEDEN

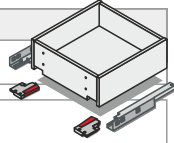

Company: \_\_\_\_\_ Person in charge: \_\_\_\_\_

Address: \_\_\_\_\_ Tel.-No.: \_\_\_\_\_

\_\_\_\_\_ E-mail: \_\_\_\_\_

	e.g.	Pos 1	Pos 2	Pos 3	Pos 4	Pos 5	Pos 6
<b>Quantity (pieces)</b>	3						
<b>Type of drawer</b> drawers: SE-32; inner drawers: SE-36 low-front drawer: SE-33; drawer-box: SE-35	32						
<b>Inside cabinet width (mm)</b> alternatively <b>drawer width (mm)</b>	862						
Please specify the inside cabinet width or alternatively the desired width of the drawer!							
<b>Inside cabinet depth (mm)</b> alternatively <b>nominal length of runner (mm)</b> alternatively <b>drawer depth (mm)</b>	550						
Please note runner lengths (see below)! Note on drawer depth: drawers for front fixing are 10 mm less deep than runners, inner drawers 3 mm deeper than runners							
<b>Height of drawer frame without runner (mm)</b> 70 / 85 / 100 / 115 / 130 / 160 / 190 / 220 / 250 / 280	115						
<b>Surface</b> melamine white [WS] / melamin light grey [GR] / melamin black [SW] / PUR white 9010 lacquered [PW]	WS						
<b>Machining front fixing</b> drilled [B] / drilled with centring dowels [C]	Only drawers (SE-32) X						
<b>Machining handle milling (Form E)</b>	Only inner drawers (SE-35 / 36)						
<b>Blum Tandem - part extension 30 kg</b> with Blumotion soft close [B] / with TipOn [T] / with TipOn incl. synchronisation [TS]	Runner lengths: 270, 300, 350, 400, 450, 500, 550, 600*, 650* *only without Blumotion soft close available						
<b>Blum Tandem - full extension 30 kg</b> with Blumotion soft close [B] / with TipOn [T] / with TipOn incl. synchronisation [TS]	Runner lengths: 250, 270, 300, 320, 350, 380, 400, 420, 450, 480, 500, 520, 550, 600						
<b>Blum Tandem - full extension 50 kg</b> with Blumotion soft close [B] / with TipOn [T] / with TipOn incl. synchronisation [TS]	Runner lengths: 450, 500, 520, 550, 580, 600, 650, 700, 750						
<b>Blum Movento - full extension 40 kg</b> with Blumotion soft close [B] / with TipOn [T] / with TipOn incl. synchronisation [TS] / with TipOn-Blumotion [TB] / with TipOn-Blumotion incl. synchronisation [TBS]	Runner lengths: 250*, 270, 300, 320, 350, 380, 400, 420, 450, 480, 500, 520, 550, 600 *not as „TipOn-Blumotion“	TBS					
<b>Blum Movento - full extension 60 / 70 kg</b> with Blumotion soft close [B] / with TipOn [T] / with TipOn incl. synchronisation [TS] / with TipOn-Blumotion [TB] / with TipOn-Blumotion incl. synchronisation [TBS]	Runner lengths: 450, 500, 520, 550, 580, 600, 650, 700*, 750* *60 kg maximum load						
<b>Grass Dynapro - full extension 40 / 50 kg</b> with Soft-close [S] / with TipMatic [T] / with TipMatic incl. synchronisation [TS]	Runner len.: 250, 270, 300, 320, 350, 380, 400, 420, 450, 480, 500, 520, 550, 600, 700*, 750* *50 kg maximum load						
<b>Grass Dynapro - full extension 70 kg</b> with Soft-close [S] / with TipMatic [T] / with TipMatic incl. synchronisation [TS]	Runner lengths: 450, 500, 520, 550, 580, 600, 650						
<b>Options</b>	Please make a cross and define on the attached sheet.						

# Bespoke drawers

## Order form MDF

Note: On this page you can add more items to your order or inquiry.

	e.g.	Pos 7	Pos 8	Pos 9	Pos 10	Pos 11	Pos 12	Pos 13	Pos 14	Pos 15
<b>Quantity (pieces)</b>	3									
<b>Type of drawer</b>	32									
<b>Inside cabinet width (mm)</b>	862									
<u>alternatively drawer width (mm)</u>										
<b>Inside cabinet depth (mm)</b>										
<u>alternatively nominal length of runner (mm)</u>	550									
<u>alternatively drawer depth (mm)</u>										
<b>Height of drawer frame without runner (mm)</b>	115									
<b>Surface</b>	WS									
<b>Machining front fixing</b>	B									
<b>Machining handle milling (Form E)</b>										
Blum Tandem - part extension 30 kg with Blumotion soft close [B] / with TipOn [T] / with TipOn incl. synchronisation [TS]										
Blum Tandem - full extension 30 kg with Blumotion soft close [B] / with TipOn [T] / with TipOn incl. synchronisation [TS]										
Blum Tandem - full extension 50 kg with Blumotion soft close [B] / with TipOn [T] / with TipOn incl. synchronisation [TS]										
Blum Movento - full extension 40 kg with Blumotion soft close [B] / with TipOn [T] / with TipOn incl. synchronisation [TS] / with TipOn-Blumotion [TB] / with TipOn-Blumotion incl. synchronisation [TBS]	TBS									
Blum Movento-Vollauszug 60 / 70 kg mit Blumotion-Dämpfung [B] / mit TipOn [T] / mit TipOn und Synchronisation [TS] / mit TipOn-Blumotion [TB] / mit TipOn-Blumotion mit Synchronisation [TBS]										
Grass Dynapro - full extension 40 / 50 kg with Soft-close [S] / with TipMatic [T] / with TipMatic incl. synchronisation [TS]										
Grass Dynapro - full extension 70 kg with Soft-close [S] / with TipMatic [T] / with TipMatic incl. synchronisation [TS]										
<b>Options</b>										

## MDF OPTIONS

Note: Please write the item number of the drawer for which the option is intended in the column "for Pos".

**Cutlery insert  
SmartLine\***

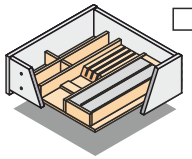

\*available for 490 and 590 mm deep drawers

**Cutlery insert  
ClassicLine**

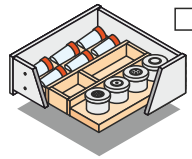

or  
please  
make a cross

for Pos	Cutlery	Knives	Foil	Spices	Tins
e.g.	X	X	X		

**Dividers and  
cross dividers**

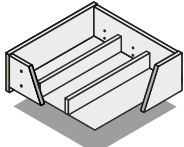
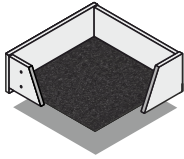

Illustration shows „lengthwise variable“

for Pos	Lengthwise fixed	Length. variable	Crosswise fixed	Crosswise loose	Crossed fixed	Double cross fix
e.g.				4 pcs		

**Insert mats  
& leather bottom**



for Pos	Needlefelt grey-melted	Anti-slip black	Imit. leather anthracite
e.g.	X		

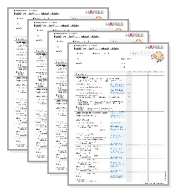

The digital version of this form, information material, type descriptions, drawings and installation aids are available from your Häfele sales office.

---

Do you need help or advice?

Call us  
**+46 36 180 088**

or send us an e-mail  
**info@hafele.se**

**Siphon cut-out**

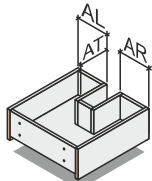

**Note:** Change/correction compared to older versions - note sketch!

for Pos	AL (distance left)	AR (distance right)	AT (depth from back)
e.g.	250	380	220

**Lock milling**

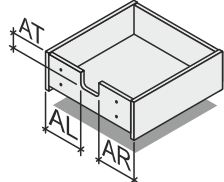

for Pos	AL (distance left)	AR (distance right)	AT (height from top)
z.B.	295	270	120

**Comments**

---



---



---

**How to order**

Please complete the order form directly on your PC or write your order by hand on a printed copy and send it to us

... via e-mail [info@hafele.se](mailto:info@hafele.se)



Version: 20230530

MDF drawers

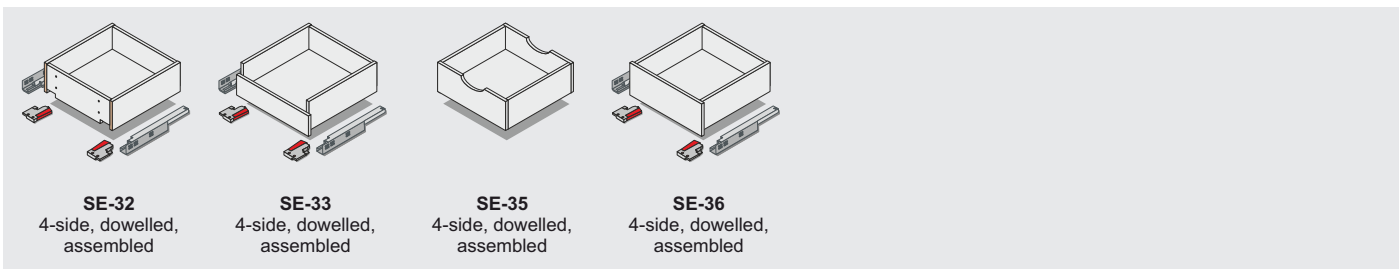

**SE-32**  
 4-side, dowelled,  
 assembled

**SE-33**  
 4-side, dowelled,  
 assembled

**SE-35**  
 4-side, dowelled,  
 assembled

**SE-36**  
 4-side, dowelled,  
 assembled

Machinings

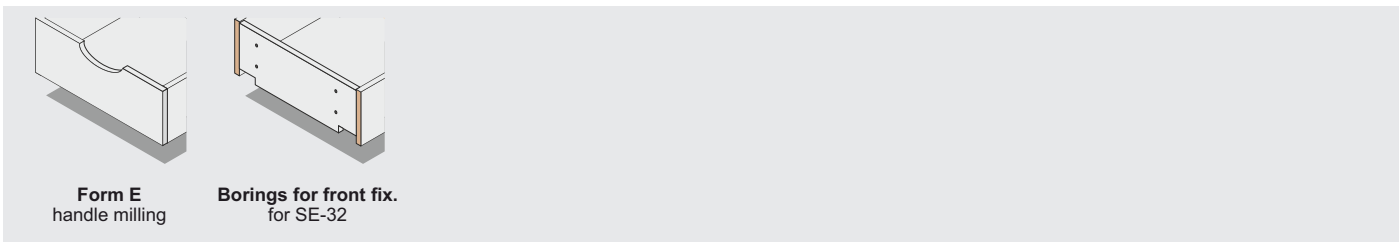

**Form E**  
 handle milling

**Borings for front fix.**  
 for SE-32

Surfaces

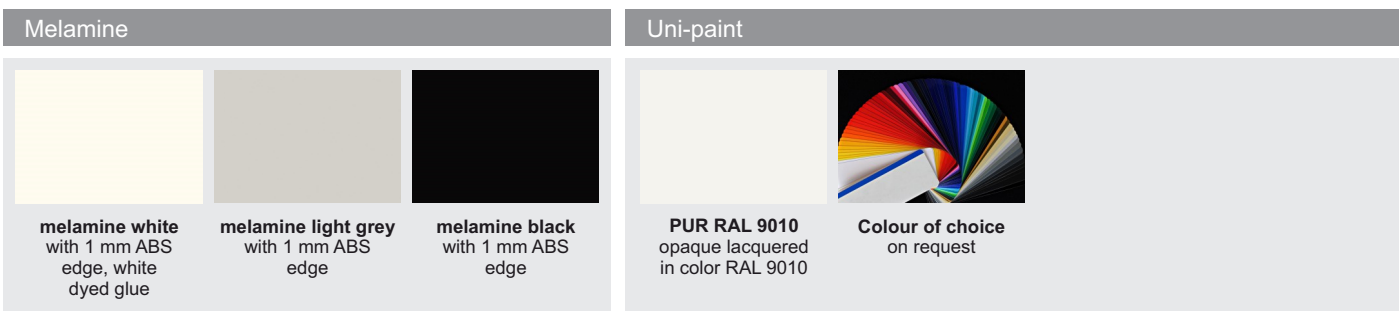

Melamine

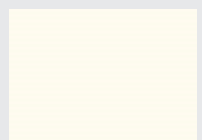

**melamine white**  
 with 1 mm ABS  
 edge, white  
 dyed glue

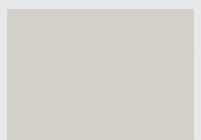

**melamine light grey**  
 with 1 mm ABS  
 edge

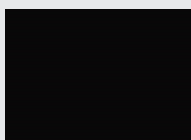

**melamine black**  
 with 1 mm ABS  
 edge

Uni-paint

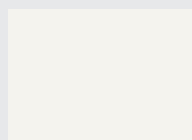

**PUR RAL 9010**  
 opaque lacquered  
 in color RAL 9010

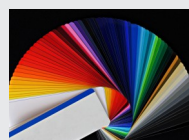

**Colour of choice**  
 on request

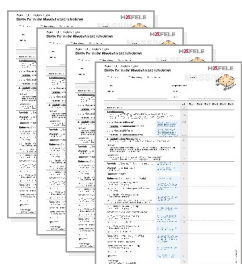

More information

The digital version of this form, information material,  
 type descriptions, drawings and installation aids  
 are available from your Häfele sales office.

Do you need help  
 or advice?

Call us  
**+46 36 180 088**

or send us an e-mail  
**info@hafele.se**