

Bespoke drawers

Order form MDF

Inquiry	Order	Desired delivery	Ref. / commission	Häfele customer no.	Sales office
<input type="checkbox"/>	<input type="checkbox"/>				Apeldoorn, NL

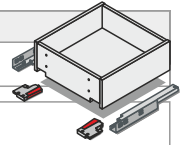

Company: _____ Person in charge: _____

Address: _____ Tel.-No.: _____

_____ E-mail: _____

	e.g.	Pos 1	Pos 2	Pos 3	Pos 4	Pos 5	Pos 6
Quantity (pieces)	3						
Type of drawer drawers: SE-32; inner drawers: SE-36 low-front drawer: SE-33; drawer-box: SE-35	32						
Inside cabinet width (mm) alternatively drawer width (mm)	862						
Please specify the inside cabinet width or alternatively the desired width of the drawer!							
Inside cabinet depth (mm) alternatively nominal length of runner (mm) alternatively drawer depth (mm)	550						
Please note runner lengths (see below)! Note on drawer depth: drawers for front fixing are 10 mm less deep than runners, inner drawers 3 mm deeper than runners							
Height of drawer frame without runner (mm) 70 / 85 / 100 / 115 / 130 / 160 / 190 / 220 / 250 / 280	115						
Surface melamine white [WS] / melamin light grey [GR] / melamin black [SW] / PUR white 9010 lacquered [PW]	WS						
Machining front fixing drilled [B] / drilled with centring dowels [C]	Only drawers (SE-32) X						
Machining handle milling (Form E)	Only inner drawers (SE-35 / 36)						
Blum Tandem - part extension 30 kg with Blumotion soft close [B] / with TipOn [T] / with TipOn incl. synchronisation [TS]	Runner lengths: 270, 300, 350, 400, 450, 500, 550, 600*, 650* *only without Blumotion soft close available						
Blum Tandem - full extension 30 kg with Blumotion soft close [B] / with TipOn [T] / with TipOn incl. synchronisation [TS]	Runner lengths: 250, 270, 300, 320, 350, 380, 400, 420, 450, 480, 500, 520, 550, 600						
Blum Tandem - full extension 50 kg with Blumotion soft close [B] / with TipOn [T] / with TipOn incl. synchronisation [TS]	Runner lengths: 450, 500, 520, 550, 580, 600, 650, 700, 750						
Blum Movento - full extension 40 kg with Blumotion soft close [B] / with TipOn [T] / with TipOn incl. synchronisation [TS] / with TipOn-Blumotion [TB] / with TipOn-Blumotion incl. synchronisation [TBS]	Runner lengths: 250*, 270, 300, 320, 350, 380, 400, 420, 450, 480, 500, 520, 550, 600 *not as „TipOn-Blumotion“	TBS					
Blum Movento - full extension 60 / 70 kg with Blumotion soft close [B] / with TipOn [T] / with TipOn incl. synchronisation [TS] / with TipOn-Blumotion [TB] / with TipOn-Blumotion incl. synchronisation [TBS]	Runner lengths: 450, 500, 520, 550, 580, 600, 650, 700*, 750* *60 kg maximum load						
Grass Dynapro - full extension 40 / 50 kg with Soft-close [S] / with TipMatic [T] / with TipMatic incl. synchronisation [TS]	Runner len.: 250, 270, 300, 320, 350, 380, 400, 420, 450, 480, 500, 520, 550, 600, 700*, 750* *50 kg maximum load						
Grass Dynapro - full extension 70 kg with Soft-close [S] / with TipMatic [T] / with TipMatic incl. synchronisation [TS]	Runner lengths: 450, 500, 520, 550, 580, 600, 650						
Options	Please make a cross and define on the attached sheet.						

Bespoke drawers

Order form MDF

Note: On this page you can add more items to your order or inquiry.

	e.g.	Pos 7	Pos 8	Pos 9	Pos 10	Pos 11	Pos 12	Pos 13	Pos 14	Pos 15
Quantity (pieces)	3									
Type of drawer	32									
Inside cabinet width (mm)	862									
<u>alternatively drawer width (mm)</u>										
Inside cabinet depth (mm)										
<u>alternatively nominal length of runner (mm)</u>	550									
<u>alternatively drawer depth (mm)</u>										
Height of drawer frame without runner (mm)	115									
Surface	WS									
Machining front fixing	B									
Machining handle milling (Form E)										
Blum Tandem - part extension 30 kg with Blumotion soft close [B] / with TipOn [T] / with TipOn incl. synchronisation [TS]										
Blum Tandem - full extension 30 kg with Blumotion soft close [B] / with TipOn [T] / with TipOn incl. synchronisation [TS]										
Blum Tandem - full extension 50 kg with Blumotion soft close [B] / with TipOn [T] / with TipOn incl. synchronisation [TS]										
Blum Movento - full extension 40 kg with Blumotion soft close [B] / with TipOn [T] / with TipOn incl. synchronisation [TS] / with TipOn-Blumotion [TB] / with TipOn-Blumotion incl. synchronisation [TBS]	TBS									
Blum Movento-Vollauszug 60 / 70 kg mit Blumotion-Dämpfung [B] / mit TipOn [T] / mit TipOn und Synchronisation [TS] / mit TipOn-Blumotion [TB] / mit TipOn-Blumotion mit Synchronisation [TBS]										
Grass Dynapro - full extension 40 / 50 kg with Soft-close [S] / with TipMatic [T] / with TipMatic incl. synchronisation [TS]										
Grass Dynapro - full extension 70 kg with Soft-close [S] / with TipMatic [T] / with TipMatic incl. synchronisation [TS]										
Options										

MDF OPTIONS

Note: Please write the item number of the drawer for which the option is intended in the column "for Pos".

**Cutlery insert
SmartLine***

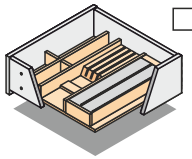

*available for 490 and 590 mm deep drawers

**Cutlery insert
ClassicLine**

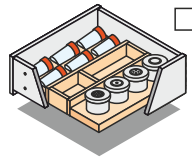

or
please make a cross

for Pos	Cutlery	Knives	Foil	Spices	Tins
e.g.	X	X	X		

**Dividers and
cross dividers**

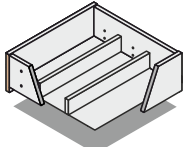
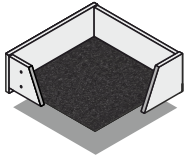

Illustration shows „lengthwise variable“

for Pos	Lengthwise fixed	Length. variable	Crosswise fixed	Crosswise loose	Crossed fixed	Double cross fix
e.g.				4 pcs		

**Insert mats
& leather bottom**



for Pos	Needlefelt grey-melted	Anti-slip black	Imit. leather anthracite
e.g.	X		

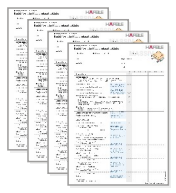

The digital version of this form, information material, type descriptions, drawings and installation aids are available from your Häfele sales office.

Do you need help or advice?

Call us
055-5384600

or send us an e-mail
info@hafele.nl

Siphon cut-out

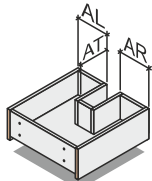

Note: Change/correction compared to older versions - note sketch!

for Pos	AL (distance left)	AR (distance right)	AT (depth from back)
e.g.	250	380	220

Lock milling

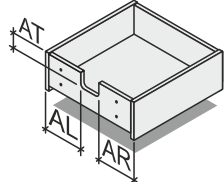

for Pos	AL (distance left)	AR (distance right)	AT (height from top)
z.B.	295	270	120

Comments

How to order

Please complete the order form directly on your PC or write your order by hand on a printed copy and send it to us

... via e-mail info@hafele.nl



MDF drawers

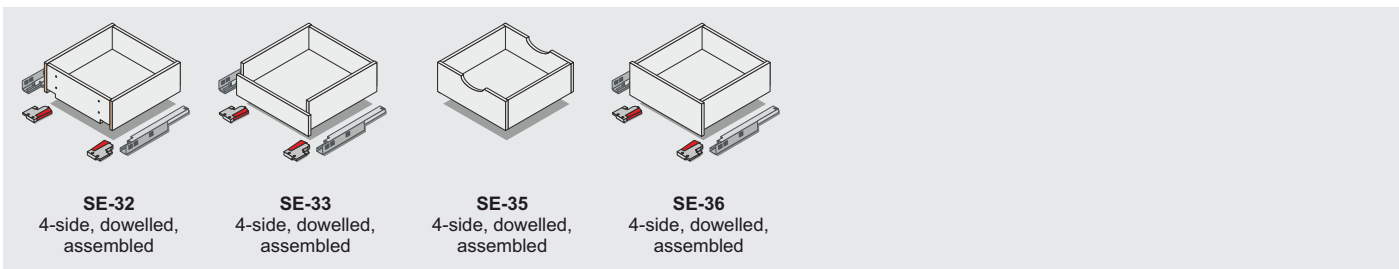

SE-32
 4-side, dowelled,
 assembled

SE-33
 4-side, dowelled,
 assembled

SE-35
 4-side, dowelled,
 assembled

SE-36
 4-side, dowelled,
 assembled

Machinings

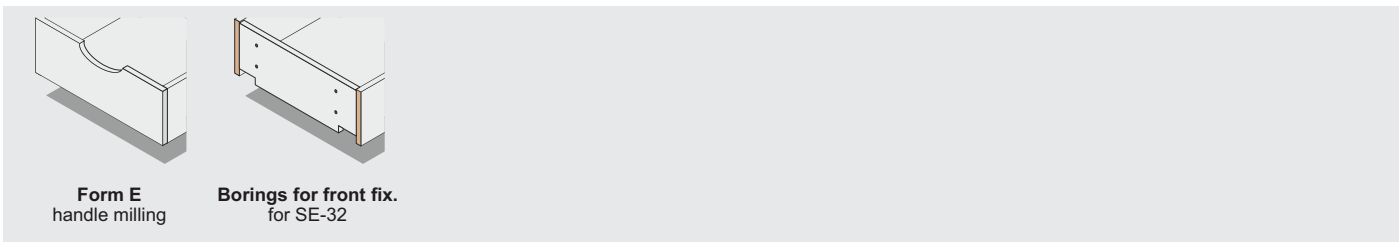

Form E
 handle milling

Borings for front fix.
 for SE-32

Surfaces

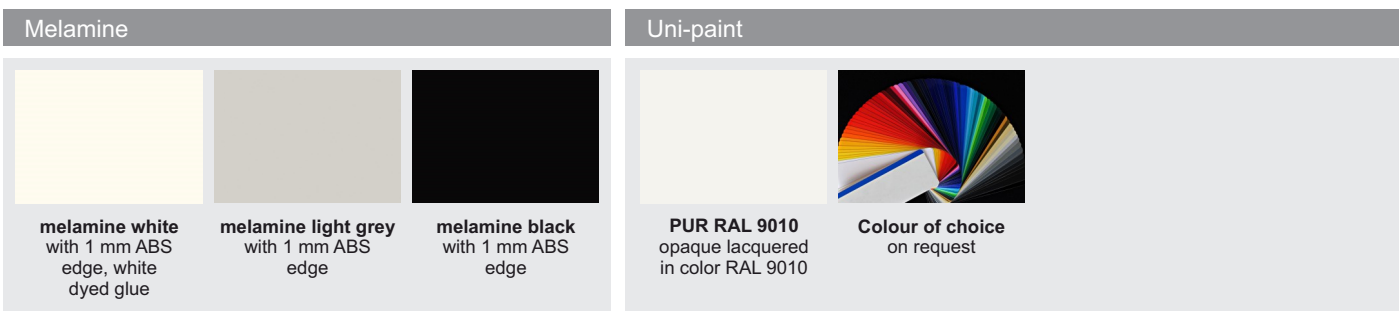

Melamine

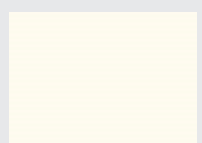

melamine white
 with 1 mm ABS
 edge, white
 dyed glue

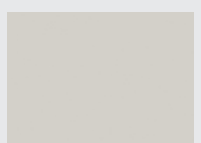

melamine light grey
 with 1 mm ABS
 edge

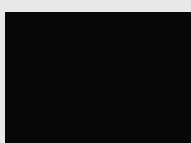

melamine black
 with 1 mm ABS
 edge

Uni-paint

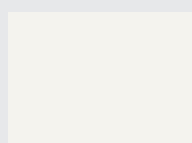

PUR RAL 9010
 opaque lacquered
 in color RAL 9010

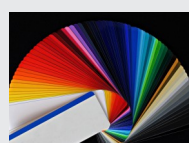

Colour of choice
 on request

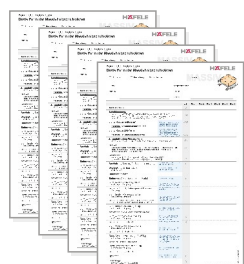

More information

The digital version of this form, information material,
 type descriptions, drawings and installation aids
 are available from your Häfele sales office.

Do you need help
 or advice?

Call us
055-5384600

or send us an e-mail
info@hafele.nl