

Bespoke drawers

Order form solid wood

Request <input type="checkbox"/>	Order <input type="checkbox"/>	Desired delivery	Ref. / Commission	Häfele customer no.	Sales office FINLAND
-------------------------------------	-----------------------------------	------------------	-------------------	---------------------	-------------------------

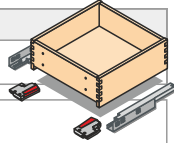

Company: _____ Person in charge: _____

Address: _____ Tel.-No.: _____

_____ E-mail: _____

	e.g.	Pos 1	Pos 2	Pos 3	Pos 4	Pos 5	Pos 6
Quantity (pieces)	3						
Type of drawer CLASSIC drawers: SE-50 / 51 / 52 / 53 inner dra.: SE-54 / 61 / 65 / 66; low-front: SE-56 / 63 / 64 pull-out (with rails): SE-72 / 73; drawer-box: SE-55 / 90 wardrobe solution „plus“: SE-20 / 21 / 22 / 29 PREMIUM: SE-40 / 41 / 42 / 43 / 44 / 45 / 46 ECO: SE-12 / SE-13 / SE-16	The drawer type defines the shape, corner connection joined / dowelled) and assembly state (assembled / disassembled). You will find an overview with visualisation and technical details in the product overview on page 4.	53					
Inside cabinet width (mm) <u>alternatively drawer width (mm)</u>	Please specify the inside cabinet width or <u>alternatively</u> the desired width of the drawer!	862					
Inside cabinet depth (mm) <u>alternatively nominal length of runner (mm)</u> <u>alternatively drawer depth (mm)</u>	Please note runner lengths (see below)! Note on drawer depth: drawers for front fixing are 10 mm less deep than runners, inner drawers 3 mm deeper than runners	550					
Height of drawer frame without runner (mm) 55 / 70 / 85 / 100 / 115 / 130 / 160 / 190 / 220 / 250 / 280 / 310 / 340 / 370 / 400		115					
Type of wood steamed beech [SBE] / pale beech [PBE] / maple [MA] / oak [OK] / smoaked oak [SOK] / knotty oak 'prime' [KOP] / oak 'character' [OKC] / americ. walnut [AWN] / black cherry [BC] / birch [BI] / ash [AS] / red elm [ELM] / pine [PIN]		EIC					
Surface nature-lacquered [L] / oiled and waxed [Ö] / nature-effect-lacquered [NL] / whitish-lacquered ¹ [WL] / grey-whitish-lacquered ² [GL] / whitish oiled [WÖ] ³ / raw, sanded [R]	¹ for beech, maple, birch & ash ² for oak ³ for beech, maple, birch, oak, birch & ash	GL					
Machining front fixing drilled [B] / drilled with centring dowels [C]	Only drawers (SE-40 / 43 / 51 / 52 / 53 / 72 / 73)	B					
Machining handle millings / borings A / B / C / D / F / handle borings [B64 / B96 / ...]	Only inner drawers (SE-16 / 41 / 44 / 46 / 54 / 55 / 61 / 65 / 66) Preview on page 5!						
Bottom loose bottom							
Bottom reinforced bottom (8 mm plywood)	Standard: 5 mm Fupla	X					
Blum Tandem - part extension 30 kg with Blumotion soft close [B] / with TipOn [T] / with TipOn incl. synchronisation [TS]	Runner lengths: 270, 300, 350, 400, 450, 500, 550, 600*, 650* *only without Blumotion soft close available						
Blum Tandem - full extension 30 kg with Blumotion soft close [B] / with TipOn [T] / with TipOn incl. synchronisation [TS]	Runner lengths: 250, 270, 300, 320, 350, 380, 400, 420, 450, 480, 500, 520, 550, 600						
Blum Tandem - full extension 50 kg with Blumotion soft close [B] / with TipOn [T] / with TipOn incl. synchronisation [TS]	Runner lengths: 450, 500, 520, 550, 580, 600, 650, 700, 750						
Blum Movento - full extension 40 kg with Blumotion soft close [B] / with TipOn [T] / with TipOn incl. synchronisation [TS] / with TipOn-Blumotion [TB] / with TipOn-Blumotion incl. synchronisation [TBS]	Runner lengths: 250*, 270, 300, 320, 350, 380, 400, 420, 450, 480, 500, 520, 550, 600 *not as „TipOn-Blumotion“	TBS					
Blum Movento - full extension 60 / 70 kg with Blumotion soft close [B] / with TipOn [T] / with TipOn incl. synchronisation [TS] / with TipOn-Blumotion [TB] / with TipOn-Blumotion incl. synchronisation [TBS]	Runner lengths: 450, 500, 520, 550, 580, 600, 650, 700*, 750* *60 kg maximum load						
Grass Dynapro - full extension 40 / 50 kg with Soft-close [S] / with TipMatic [T] / with TipMatic incl. synchronisation [TS]	Runner len.: 250, 270, 300, 320, 350, 380, 400, 420, 450, 480, 500, 520, 550, 600, 700*, 750* *50 kg maximum load						
Grass Dynapro - full extension 70 kg with Soft-close [S] / with TipMatic [T] / with TipMatic incl. synchronisation [TS]	Runner lengths: 450, 500, 520, 550, 580, 600, 650						
Options	Please make a cross and define on the attached sheet.						
Laser-Logo left [L] / right [R] / both sides [B]	A one-time charge for set-up and sampling applies to the first order.						

Bespoke drawers

Order form solid wood

Note: On this page you can add more items to your order or inquiry.

	e.g.	Pos 7	Pos 8	Pos 9	Pos 10	Pos 11	Pos 12	Pos 13	Pos 14	Pos 15
Quantity (pieces)	3									
Type of drawer	53									
Inside cabinet width (mm)	862									
<u>alternatively drawer width (mm)</u>										
Inside cabinet depth (mm)										
<u>alternatively nominal length of runner (mm)</u>	550									
<u>alternatively drawer depth (mm)</u>										
Height of drawer frame without runners (mm)	115									
Type of wppd	EIC									
Surface	L									
Machining front fixing	B									
Machining handle millings / borings										
Bottom loose bottom										
Bottom reinforced bottom (8 mm plywood)	X									
Blum Tandem - part extension 30 kg with Blumotion soft close [B] / with TipOn [T] / with TipOn incl. synchronisation [TS]										
Blum Tandem - full extension 30 kg with Blumotion soft close [B] / with TipOn [T] / with TipOn incl. synchronisation [TS]										
Blum Tandem - full extension 50 kg with Blumotion soft close [B] / with TipOn [T] / with TipOn incl. synchronisation [TS]										
Blum Movento - full extension 40 kg with Blumotion soft close [B] / with TipOn [T] / with TipOn incl. synchronisation [TS] / with TipOn-Blumotion [TB] / with TipOn-Blumotion incl. synchronisation [TBS]	TBS									
Blum Movento - full extension 60 / 70 kg with Blumotion soft close [B] / with TipOn [T] / with TipOn incl. synchronisation [TS] / with TipOn-Blumotion [TB] / with TipOn-Blumotion incl. synchronisation [TBS]										
Grass Dynapro - full extension 40 / 50 kg with Soft-close [S] / with TipMatic [T] / with TipMatic incl. synchronisation [TS]										
Grass Dynapro - full extension 70 kg with Soft-close [S] / with TipMatic [T] / with TipMatic incl. synchronisation [TS]										
Options										
Laser-Logo left [L] / right [R] / both sides [B]										

SOLID OPTIONS

Note: Please write the item number of the drawer for which the option is intended in the column "for Pos".

Cutlery insert SmartLine*

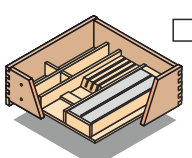

*available for 490 and 590 mm deep drawers

Cutlery insert ClassicLine



or
please make a cross

for Pos	Cutlery	Knives	Foil	Spices	Tins
e.g.	X	X	X		

Dividers and cross dividers

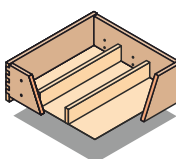
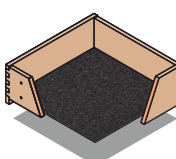

Illustration shows „lengthwise variable“

for Pos	Lengthwise fixed	Length. variable	Crosswise fixed	Crosswise loose	Crossed fixed	Double cross fix
e.g.				4 pcs		

Insert mats & leather bottom



for Pos	Needlefelt grey-melted	Anti-slip black	Imit. leather anthracite
e.g.	X		

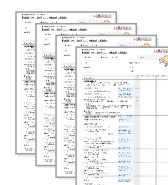

The digital version of this form, information material, type descriptions, drawings and installation aids are available from your Häfele sales office.

Siphon cut-out

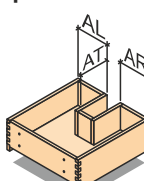

Note: Change/correction compared to older versions - note sketch!

for Pos	AL (distance left)	AR (distance right)	AT (depth from back)
e.g.	250	380	220

Lock milling

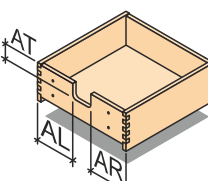

for Pos	AL (distance left)	AR (distance right)	AT (height from top)
z.B.	295	270	120

Do you need help or advice?

Call us
+358 3 877770

or send us an e-mail
info@hafele.fi

Comments

How to order

Please complete the order form directly on your PC or write your order by hand on a printed copy and send it to us

... via e-mail info@hafele.fi



Bespoke drawers

Product overview solid wood drawers

Classic

Drawers behind fronts				Pull-outs with side railing		
<p>SE-50 3-sides, dowelled, unassembled</p>	<p>SE-51 4-sides, dowelled, unassembled</p>	<p>SE-52 4-sides, dowelled, assembled</p>	<p>SE-53 4-sides, jointed, assembled</p>	<p>SE-72 4-sides, dowelled, assembled</p>	<p>SE-73 4-sides, jointed, assembled</p>	
Inner drawers				Low-front drawers		
<p>SE-65 Front flush with sides, dowelled</p>	<p>SE-66 Front protruding below, dowelled</p>	<p>SE-54 Front flush with sides, jointed</p>	<p>SE-61 Front protruding below, jointed</p>	<p>SE-63 Front protruding below, dowelled</p>	<p>SE-56 Front flush with sides, jointed</p>	<p>SE-64 Front protruding below, jointed</p>
Drawer-boxes		Wardrobe solution ,plus'				
<p>SE-55 jointed, assembled</p>	<p>SE-90 Insert, dowelled, assembled</p>	<p>SE-20 Front protr. below & to sides, dowelled</p>	<p>SE-21 Front protr. below & to sides, clear/satin</p>	<p>SE-22 Front protr. below & to sides, clear/satin</p>	<p>SE-29 Pull-out for trousers, aluminium traverse</p>	

Premium

Premium drawers are sanded flat on the top side after assembly. All edges are slightly broken. The bottom made of 8 mm thick veneer board is grooved and glued on 4 sides. The joint spacing is fine and even. The drawers SE-40, SE-41 and SE-42 are supplied with semi-concealed dovetail joints. The front piece of the SE-46 internal drawer is tapped so that it can protrude to the side and conceal the runner.

<p>SE-40 Drawer, dovetailed</p>	<p>SE-41 Inner drawer, dovetailed</p>	<p>SE-42 Low-front drawer, straight / curved side, dovetailed</p>	<p>SE-43 Drawers, finger jointed</p>	<p>SE-44 Inner drawer, finger jointed</p>	<p>SE-45 Low-front drawer, straight side, finger jointed</p>	<p>SE-46 Inner drawer, protruding on 4 sides, tapped</p>
--	--	--	---	--	---	---

Eco

Eco drawers are produced similarly to decor drawers and are only available with dowelled corner joints. The drawers are already primed in the profile on both sides and are therefore not sanded flush after assembly. Due to tolerances, there may be a small offset between the front/rear piece and the sides. Eco drawers are only available in the wood types "Steamed beech" and "Oak character".

<p>SE-12 Drawer, dowelled</p>	<p>SE-13 Pull-out, dowelled</p>	<p>SE-16 Inner drawer, dowelled</p>
--	--	--

Machinings

Handle millings / borings

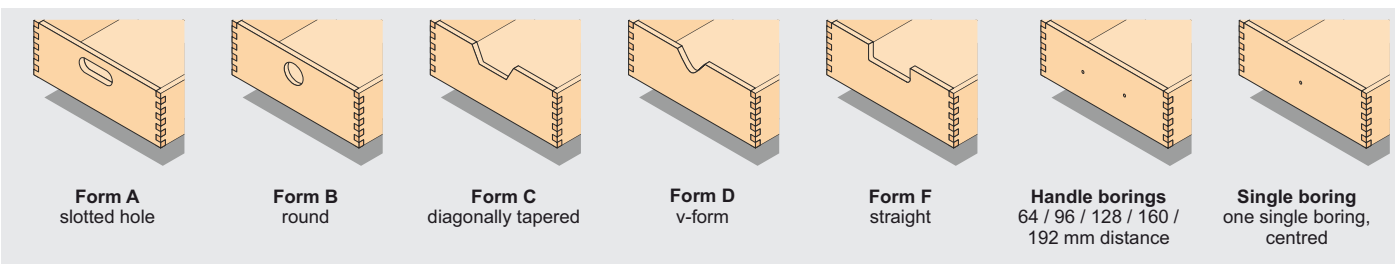

Types of wood & surfaces

Types of wood



Surfaces

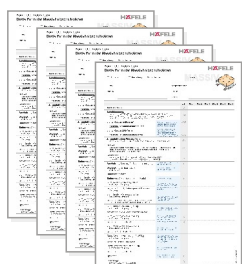

More information

The digital version of this form, information material, type descriptions, drawings and installation aids are available from your Häfele sales office.

Do you need help or advice?

Call us
+358 3 877770

or send us an e-mail
info@hafele.fi